

Certifications

IEC 61914:2015 - Approved by RTE

Section

Single aluminium cleats

Application

Field

**PRODUCT BENEFITS**

easy to close with our registered hinges system.

Stainless steel screws with anti-friction coating.

High resistance to landslides in vertical.

TOOL CAPACITY

Diameter 72 - 77 mm
2,835 - 3,031 inch

Material AS13 aluminium / stainless steel

Version Nut

TOOL DIMENSIONS

Length 145 mm

Width 80 mm

Height 150 mm

Weight without box 0,83 Kg

Packaging None

ALROC SAS

Z.I. de la Fonderie - 72160 TUFFE
FRANCE

Phone: +33 2 43 71 11 80

Fax number : +33 2 43 71 16 51

www.alroc.fr

Simple cleat of hinges Ø90 nut version**TO DO WHAT**

Our range of CSC simple cleats allows the maintenance of underground cables for the distribution and transmission of electricity.

Indoor or outdoor installation. SEMC, transformers, wells...

Must be associated with a protective fur (To order separately).

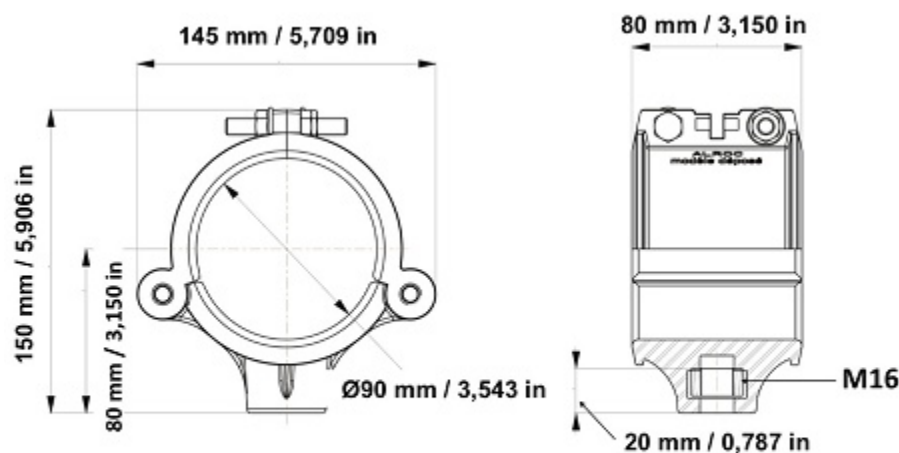
**Options**

LTF16-140 - Threaded rod connection M16

LCA-MMA - Articulated rod connection aluminium M16. Also available in inox version LCA-MMI

EC16 - M16 castellated nut

EQC16/00 - Base for M16 cleat. Also available in EQC16/50

VIL16/60 - Special screw M16

Associated tool

PCA10-90 - Protection for Ø72 to 74mm / Ø2,835 to 2,913in cable

PCA8-90 - Protection for Ø74 to 77mm / Ø2,913 to 3,032in cable

CAD - Socket wrench

CAE - Pin wrench



Part Number	Diameter	Tool capacity		Dimensions			Packaging
		Material	Version	Length	Width	Height	
CSC100E	82 - 87 mm 3,228 - 3,425 in	AS13 aluminium / stainless steel	Nut	157 mm 6,181 in	100 mm 3,937 in	163 mm 6,417 in	none
CSC100V	82 - 87 mm 3,228 - 3,425 in	AS13 aluminium / stainless steel	Screw	157 mm 6,181 in	100 mm 3,937 in	163 mm 6,417 in	none
CSC105E	87 - 92 mm 3,425 - 3,622 in	AS13 aluminium / stainless steel	Nut	163 mm 6,417 in	100 mm 3,937 in	168 mm 6,614 in	none
CSC105V	87 - 92 mm 3,425 - 3,622 in	AS13 aluminium / stainless steel	Screw	163 mm 6,417 in	100 mm 3,937 in	168 mm 6,614 in	none
CSC110E	92 - 97 mm 3,622 - 3,819 in	AS13 aluminium / stainless steel	Nut	169 mm 6,654 in	100 mm 3,937 in	175 mm 6,890 in	none
CSC110V	92 - 97 mm 3,622 - 3,819 in	AS13 aluminium / stainless steel	Screw	169 mm 6,654 in	100 mm 3,937 in	175 mm 6,890 in	none
CSC115E	97 - 102 mm 3,819 - 4,016 in	AS13 aluminium / stainless steel	Nut	174 mm 6,850 in	100 mm 3,937 in	180 mm 7,087 in	none
CSC115V	97 - 102 mm 3,819 - 4,016 in	AS13 aluminium / stainless steel	Screw	174 mm 6,850 in	100 mm 3,937 in	180 mm 7,087 in	none
CSC120E	102 - 107 mm 4,016 - 4,213 in	AS13 aluminium / stainless steel	Nut	180 mm 7,087 in	100 mm 3,937 in	186 mm 7,323 in	none
CSC120V	102 - 107 mm 4,016 - 4,213 in	AS13 aluminium / stainless steel	Screw	180 mm 7,087 in	100 mm 3,937 in	186 mm 7,323 in	none
CSC125E	107 - 112 mm 4,213 - 4,409 in	AS13 aluminium / stainless steel	Nut	186 mm 7,323 in	100 mm 3,937 in	191 mm 7,520 in	none
CSC125V	107 - 112 mm 4,213 - 4,409 in	AS13 aluminium / stainless steel	Screw	186 mm 7,323 in	100 mm 3,937 in	191 mm 7,520 in	none
CSC130E	112 - 117 mm 4,409 - 4,606 in	AS13 aluminium / stainless steel	Nut	192 mm 7,559 in	100 mm 3,937 in	194 mm 7,638 in	none
CSC130V	112 - 117 mm 4,409 - 4,606 in	AS13 aluminium / stainless steel	Screw	192 mm 7,559 in	100 mm 3,937 in	194 mm 7,638 in	none
CSC135E	112 - 117 mm 4,409 - 4,606 in	AS13 aluminium / stainless steel	Nut	198 mm 7,795 in	100 mm 3,937 in	205 mm 8,071 in	none
CSC135V	117 - 122 mm 4,606 - 4,803 in	AS13 aluminium / stainless steel	Screw	198 mm 7,795 in	100 mm 3,937 in	205 mm 8,071 in	none
CSC140E	112 - 117 mm 4,409 - 4,606 in	AS13 aluminium / stainless steel	Nut	201 mm 7,913 in	100 mm 3,937 in	205 mm 8,071 in	none

Cleats, saddles and accessories

CSC90E



CSC140V	122 - 127 mm 4,803 - 5,000 in	AS13 aluminium / stainless steel	Screw	201 mm 7,913 in	100 mm 3,937 in	205 mm 8,071 in	none
CSC47,5E	35 - 39 mm 1,378 - 1,535 in	AS13 aluminium / stainless steel	Nut	100 mm 3,937 in	45 mm 1,772 in	91 mm 3,583 in	none
CSC47,5V	35 - 39 mm 1,378 - 1,535 in	AS13 aluminium / stainless steel	Screw	100 mm 3,937 in	45 mm 1,772 in	91 mm 3,583 in	none
CSC60E	47 - 52 mm 1,850 - 2,047 in	AS13 aluminium / stainless steel	Nut	112 mm 4,409 in	66 mm 2,598 in	121 mm 4,764 in	none
CSC60V	42 - 47 mm 1,654 - 1,850 in	AS13 aluminium / stainless steel	Screw	112 mm 4,409 in	66 mm 2,598 in	121 mm 4,764 in	none
CSC65E	47 - 52 mm 1,850 - 2,047 in	AS13 aluminium / stainless steel	Nut	112 mm 4,409 in	66 mm 2,598 in	121 mm 4,764 in	none
CSC65V	47 - 52 mm 1,850 - 2,047 in	AS13 aluminium / stainless steel	Screw	112 mm 4,409 in	66 mm 2,598 in	121 mm 4,764 in	none
CSC70E	52 - 57 mm 2,047 - 2,244 in	AS13 aluminium / stainless steel	Nut	121 mm 4,764 in	66 mm 2,598 in	125 mm 4,921 in	none
CSC70V	52 - 57 mm 2,047 - 2,244 in	AS13 aluminium / stainless steel	Screw	121 mm 4,764 in	66 mm 2,598 in	125 mm 4,921 in	none
CSC75E	57 - 62 mm 2,244 - 2,441 in	AS13 aluminium / stainless steel	Nut	126 mm 4,961 in	66 mm 2,598 in	131 mm 5,157 in	none
CSC75V	57 - 62 mm 2,244 - 2,441 in	AS13 aluminium / stainless steel	Screw	126 mm 4,961 in	66 mm 2,598 in	131 mm 5,157 in	none
CSC80E	62 - 67 mm 2,441 - 2,638 in	AS13 aluminium / stainless steel	Nut	134 mm 5,276 in	80 mm 3,150 in	138 mm 5,433 in	none
CSC80V	62 - 67 mm 2,441 - 2,638 in	AS13 aluminium / stainless steel	Screw	134 mm 5,276 in	80 mm 3,150 in	138 mm 5,433 in	none
CSC85E	67 - 72 mm 2,638 - 2,835 in	AS13 aluminium / stainless steel	Nut	140 mm 5,512 in	80 mm 3,150 in	144 mm 5,669 in	none
CSC85V	67 - 72 mm 2,638 - 2,835 in	AS13 aluminium / stainless steel	Screw	140 mm 5,512 in	80 mm 3,150 in	144 mm 5,669 in	none
CSC90E	72 - 77 mm 2,835 - 3,031 in	AS13 aluminium / stainless steel	Nut	145 mm 5,709 in	80 mm 3,150 in	150 mm 5,906 in	none
CSC90V	72 - 77 mm 2,835 - 3,031 in	AS13 aluminium / stainless steel	Screw	145 mm 5,709 in	80 mm 3,150 in	150 mm 5,906 in	none
CSC95E	77 - 82 mm 3,031 - 3,228 in	AS13 aluminium / stainless steel	Nut	151 mm 5,945 in	100 mm 3,937 in	158 mm 6,220 in	none
CSC95V	77 - 82 mm 3,031 - 3,228 in	AS13 aluminium / stainless steel	Screw	151 mm 5,945 in	100 mm 3,937 in	158 mm 6,220 in	none