

Certifications

IEC 61914:2015 - Approved by RTE

Section

Single aluminium cleats

Application

Field

**PRODUCT BENEFITS**

easy to close with our registered hinges system.

Stainless steel screws with anti-friction coating.

High resistance to landslides in vertical.

TOOL CAPACITY

Diameter 97 - 102 mm
3,819 - 4,016 inch

Material AS13 aluminium / stainless steel

Version Nut

TOOL DIMENSIONS

Length 174 mm

Width 100 mm

Height 180 mm

Weight without box 1,35 Kg

Packaging None

ALROC SAS

Z.I. de la Fonderie - 72160 TUFFE
FRANCE

Phone: +33 2 43 71 11 80

Fax number : +33 2 43 71 16 51

www.alroc.fr

Simple cleat of hinges Ø115 nut version

TO DO WHAT

Our range of CSC simple cleats allows the maintenance of underground cables for the distribution and transmission of electricity.

Indoor or outdoor installation. SEMC, transformers, wells...

Must be associated with a protective fur (To order separately).

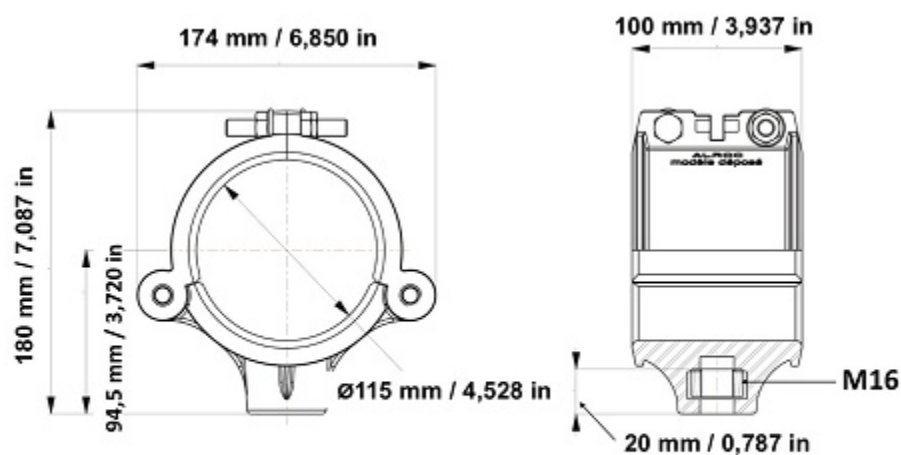
**Options**

LTF16-140 - Threaded rod connection M16

LCA-MMA - Articulated rod connection aluminium M16. Also available in inox version LCA-MMI

EC16 - M16 castellated nut

EQC16/00 - Base for M16 cleat. Also available in EQC16/50

VIL16/60 - Special screw M16

Associated tool

PCA10-115 - Protection for Ø97 to 99mm / Ø3,819 to 3,898in cable

PCA8-115 - Protection for Ø99 to 102mm / Ø3,898 to 4,016in cable

CAD - Socket wrench

CAE - Pin wrench



Part Number	Diameter	Tool capacity		Dimensions			Packaging
		Material	Version	Length	Width	Height	
CSC100E	82 - 87 mm 3,228 - 3,425 in	AS13 aluminium / stainless steel	Nut	157 mm 6,181 in	100 mm 3,937 in	163 mm 6,417 in	none
CSC100V	82 - 87 mm 3,228 - 3,425 in	AS13 aluminium / stainless steel	Screw	157 mm 6,181 in	100 mm 3,937 in	163 mm 6,417 in	none
CSC105E	87 - 92 mm 3,425 - 3,622 in	AS13 aluminium / stainless steel	Nut	163 mm 6,417 in	100 mm 3,937 in	168 mm 6,614 in	none
CSC105V	87 - 92 mm 3,425 - 3,622 in	AS13 aluminium / stainless steel	Screw	163 mm 6,417 in	100 mm 3,937 in	168 mm 6,614 in	none
CSC110E	92 - 97 mm 3,622 - 3,819 in	AS13 aluminium / stainless steel	Nut	169 mm 6,654 in	100 mm 3,937 in	175 mm 6,890 in	none
CSC110V	92 - 97 mm 3,622 - 3,819 in	AS13 aluminium / stainless steel	Screw	169 mm 6,654 in	100 mm 3,937 in	175 mm 6,890 in	none
CSC115E	97 - 102 mm 3,819 - 4,016 in	AS13 aluminium / stainless steel	Nut	174 mm 6,850 in	100 mm 3,937 in	180 mm 7,087 in	none
CSC115V	97 - 102 mm 3,819 - 4,016 in	AS13 aluminium / stainless steel	Screw	174 mm 6,850 in	100 mm 3,937 in	180 mm 7,087 in	none
CSC120E	102 - 107 mm 4,016 - 4,213 in	AS13 aluminium / stainless steel	Nut	180 mm 7,087 in	100 mm 3,937 in	186 mm 7,323 in	none
CSC120V	102 - 107 mm 4,016 - 4,213 in	AS13 aluminium / stainless steel	Screw	180 mm 7,087 in	100 mm 3,937 in	186 mm 7,323 in	none
CSC125E	107 - 112 mm 4,213 - 4,409 in	AS13 aluminium / stainless steel	Nut	186 mm 7,323 in	100 mm 3,937 in	191 mm 7,520 in	none
CSC125V	107 - 112 mm 4,213 - 4,409 in	AS13 aluminium / stainless steel	Screw	186 mm 7,323 in	100 mm 3,937 in	191 mm 7,520 in	none
CSC130E	112 - 117 mm 4,409 - 4,606 in	AS13 aluminium / stainless steel	Nut	192 mm 7,559 in	100 mm 3,937 in	194 mm 7,638 in	none
CSC130V	112 - 117 mm 4,409 - 4,606 in	AS13 aluminium / stainless steel	Screw	192 mm 7,559 in	100 mm 3,937 in	194 mm 7,638 in	none
CSC135E	112 - 117 mm 4,409 - 4,606 in	AS13 aluminium / stainless steel	Nut	198 mm 7,795 in	100 mm 3,937 in	205 mm 8,071 in	none
CSC135V	117 - 122 mm 4,606 - 4,803 in	AS13 aluminium / stainless steel	Screw	198 mm 7,795 in	100 mm 3,937 in	205 mm 8,071 in	none
CSC140E	112 - 117 mm 4,409 - 4,606 in	AS13 aluminium / stainless steel	Nut	201 mm 7,913 in	100 mm 3,937 in	205 mm 8,071 in	none

Cleats, saddles and accessories

CSC115E



CSC140V	122 - 127 mm 4,803 - 5,000 in	AS13 aluminium / stainless steel	Screw	201 mm 7,913 in	100 mm 3,937 in	205 mm 8,071 in	none
CSC47,5E	35 - 39 mm 1,378 - 1,535 in	AS13 aluminium / stainless steel	Nut	100 mm 3,937 in	45 mm 1,772 in	91 mm 3,583 in	none
CSC47,5V	35 - 39 mm 1,378 - 1,535 in	AS13 aluminium / stainless steel	Screw	100 mm 3,937 in	45 mm 1,772 in	91 mm 3,583 in	none
CSC60E	47 - 52 mm 1,850 - 2,047 in	AS13 aluminium / stainless steel	Nut	112 mm 4,409 in	66 mm 2,598 in	121 mm 4,764 in	none
CSC60V	42 - 47 mm 1,654 - 1,850 in	AS13 aluminium / stainless steel	Screw	112 mm 4,409 in	66 mm 2,598 in	121 mm 4,764 in	none
CSC65E	47 - 52 mm 1,850 - 2,047 in	AS13 aluminium / stainless steel	Nut	112 mm 4,409 in	66 mm 2,598 in	121 mm 4,764 in	none
CSC65V	47 - 52 mm 1,850 - 2,047 in	AS13 aluminium / stainless steel	Screw	112 mm 4,409 in	66 mm 2,598 in	121 mm 4,764 in	none
CSC70E	52 - 57 mm 2,047 - 2,244 in	AS13 aluminium / stainless steel	Nut	121 mm 4,764 in	66 mm 2,598 in	125 mm 4,921 in	none
CSC70V	52 - 57 mm 2,047 - 2,244 in	AS13 aluminium / stainless steel	Screw	121 mm 4,764 in	66 mm 2,598 in	125 mm 4,921 in	none
CSC75E	57 - 62 mm 2,244 - 2,441 in	AS13 aluminium / stainless steel	Nut	126 mm 4,961 in	66 mm 2,598 in	131 mm 5,157 in	none
CSC75V	57 - 62 mm 2,244 - 2,441 in	AS13 aluminium / stainless steel	Screw	126 mm 4,961 in	66 mm 2,598 in	131 mm 5,157 in	none
CSC80E	62 - 67 mm 2,441 - 2,638 in	AS13 aluminium / stainless steel	Nut	134 mm 5,276 in	80 mm 3,150 in	138 mm 5,433 in	none
CSC80V	62 - 67 mm 2,441 - 2,638 in	AS13 aluminium / stainless steel	Screw	134 mm 5,276 in	80 mm 3,150 in	138 mm 5,433 in	none
CSC85E	67 - 72 mm 2,638 - 2,835 in	AS13 aluminium / stainless steel	Nut	140 mm 5,512 in	80 mm 3,150 in	144 mm 5,669 in	none
CSC85V	67 - 72 mm 2,638 - 2,835 in	AS13 aluminium / stainless steel	Screw	140 mm 5,512 in	80 mm 3,150 in	144 mm 5,669 in	none
CSC90E	72 - 77 mm 2,835 - 3,031 in	AS13 aluminium / stainless steel	Nut	145 mm 5,709 in	80 mm 3,150 in	150 mm 5,906 in	none
CSC90V	72 - 77 mm 2,835 - 3,031 in	AS13 aluminium / stainless steel	Screw	145 mm 5,709 in	80 mm 3,150 in	150 mm 5,906 in	none
CSC95E	77 - 82 mm 3,031 - 3,228 in	AS13 aluminium / stainless steel	Nut	151 mm 5,945 in	100 mm 3,937 in	158 mm 6,220 in	none
CSC95V	77 - 82 mm 3,031 - 3,228 in	AS13 aluminium / stainless steel	Screw	151 mm 5,945 in	100 mm 3,937 in	158 mm 6,220 in	none